



*Growing green fields and
a green environment...*

**Irrigation Products**
Total Solution of Water Supply

Mini Sprinkler-1/2"



Features & Specification

- ➔ 1/2" Male threaded intel connection.
- ➔ Option Sand protection cover to protect the spring from sand.
- ➔ Sainless steel retraction spring maintain uniform rotation speed.
- ➔ Low friction coefficient Engineering plastic pivot pin for smooth rotating of arm.
- ➔ 1.20 Mtr of long PVC pipe.
- ➔ Use in UV stabilizer.
- ➔ Full Circle.
- ➔ Low operating pressure.

Application

- ➔ Use in Potato, Onion, Groundnut, Cabbage, Pulses, Tea, Strawberry etc.

Performance data

Nozzal size(mm)	Pressure (kg/cm ²)	Watted Diameter (mtr)	Discharge (ltr/min)
2.5 X 1.8	1.0	17.0	7.5
	2.0	18.5	8.0
	2.5	19.0	8.5
	3.0	20.0	9.5



Female Connector



Male Connector



End Stop



Spanner

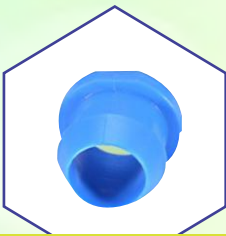

Female Connector



Male Connector

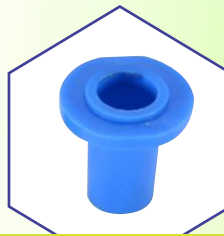

End Stop



Strong Ribbed Adopter



8mm Punch & Pusher



Male Connector

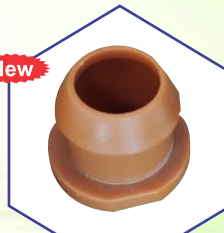

Female Connector



End Stop

"The Best Sprinkler Equipment For Your Farm"



Mini Sprinkler

Features & Specification

- Fast and easy leak proof connection
- High impact resistance to pulsed pressure.
- Available in 32mm



Joiner



Elbow



MTA



End Cap



Heavy Tee

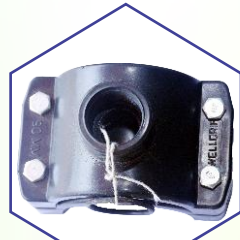

Service Saddle



SS Patti Valve



3 Side & 2 side Cap Tee



Hex Nipple



Inner side Thread Hex Nipple

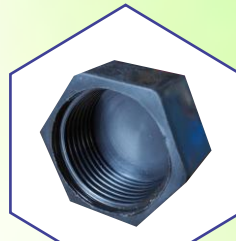

Thread Cap



Mini Airvalve



Solid Seal Ball Valve
(Long Handle)

Size : 1/2" to 4"
Brand : Welldrip

PP Air Valve

Size : 1"
Brand : Poonam



Sprinkler Fittings



Single Union Valve

32 mm
Material : PP
Brand : Poonam Renfit



Pressure Gauge

Dial : 2.5"
Glycerine Filled
Threaded Size : 1/4" BSP Male



Venturi Injector

Size : 2"
Material : PP & Nylon-6

Venturi
Saolid Valve
Hax Nipple
Foot Valve



Flange

63, 75, 110 mm
Product : PP Flange, PP Telfish,
PP Thread Flange



Flush Valve

20, 63 & 75 mm
Material : PP, & ABS

Fogger Nozzle



Mini Sprinkler



New



Single Union Valve



PP Butterfly Valve

63, 75, 90 mm
Material : PP

Drip Fittings



Joiner & Takeoff

12, 16 & 20 mm
Material : PP & Polyacetal

Ring Lock Joiner
Pepsi Joiner
Simple Joiner
Ring Takeoff
Pepsi Takeoff
Simple Takeoff



Tee & Elbow

12, 16 & 20 mm
Material : PP & Polyacetal



End Cap

12, 16 & 20 mm
Material : PP & LD



Lateral Cock

12, 16 & 20 mm
Material : PP & LD

pepsi Lateral Cock
Simple Lateral Cock



Rubber Gromet

12, 16 & 20 mm
Material : EPDM & Nitrile



Online Dripper

8 & 14 LPH (Non ISI)
Material : PP, LD & Eva

Dripper Punch
Dripper Plug
Mnicro Connector
Micro Tee

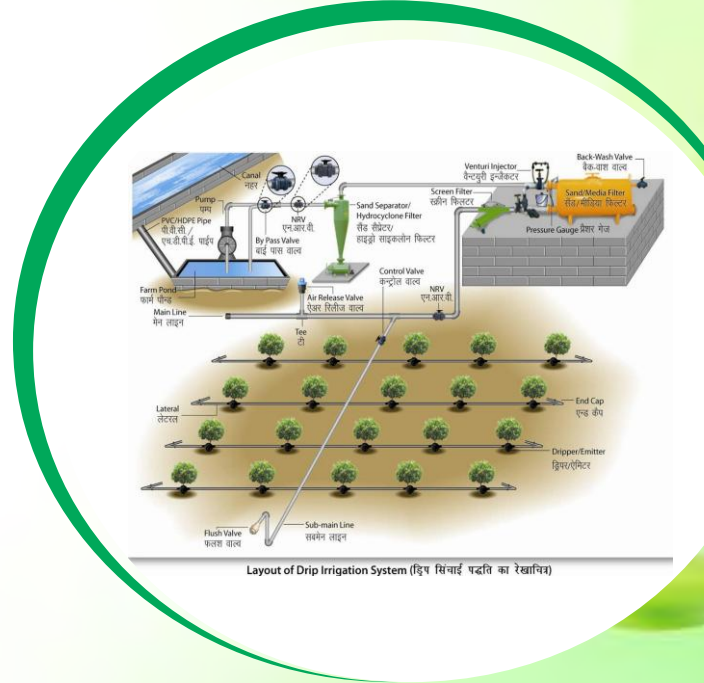

Adjustable Driper

Sprinkler (Nozzle)



Adjustable Sprinkler - 1/2"
(half Circle)

Color : Black
Suitable For : Watering Equipment
Width : 14.5 cm
Length : 19 cm
Weight : 0.15 kg

Features

- Watering Coverage : 40 feet (20 feet radius)
- Connection Threading : 3/4" (25mm) Male Thread
- Additional Nozzle Provided : yes
- Sprinkler won't work with top water pressure
- Pressurized water (water pump) is recommended.

Micro Sprinkler



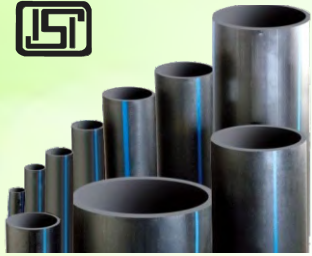

Brand : "WELLD RIP"

Push Fitting

HDPE Pipes are manufactured as per IS 4984: 1995, 32 to 110 mm in all pressure class manufacturing from material grade PE 63, PE80. Also, planning to get another standards as per requirement. Available in ISI & Non ISI

Advantages

- Corrosion Resistant
- Flexible
- Tough
- Chemically Inert
- Abrasion Resistant
- Smooth Surface
- Easy & Quick Installation

Application

- Slurry Transportation
- Potable Water Supply
- Industrial Effluents
- Irrigation/Agriculture
- Sewerage & Drainage
- Sprinkler System
- Gas Transmission



Irrigation Lateral

16, 20 & 32 mm

Standard : ISI / Non ISI

Application : Drip, Micro Sprinkler & Mini Sprinkler



Drip Pipe

16 mm dia with spacing of 30 cm to 150 cm with discharge of 2LPH to 4LPH

Standard : ISI / Non ISI

Application : to irrigate close spacing crops



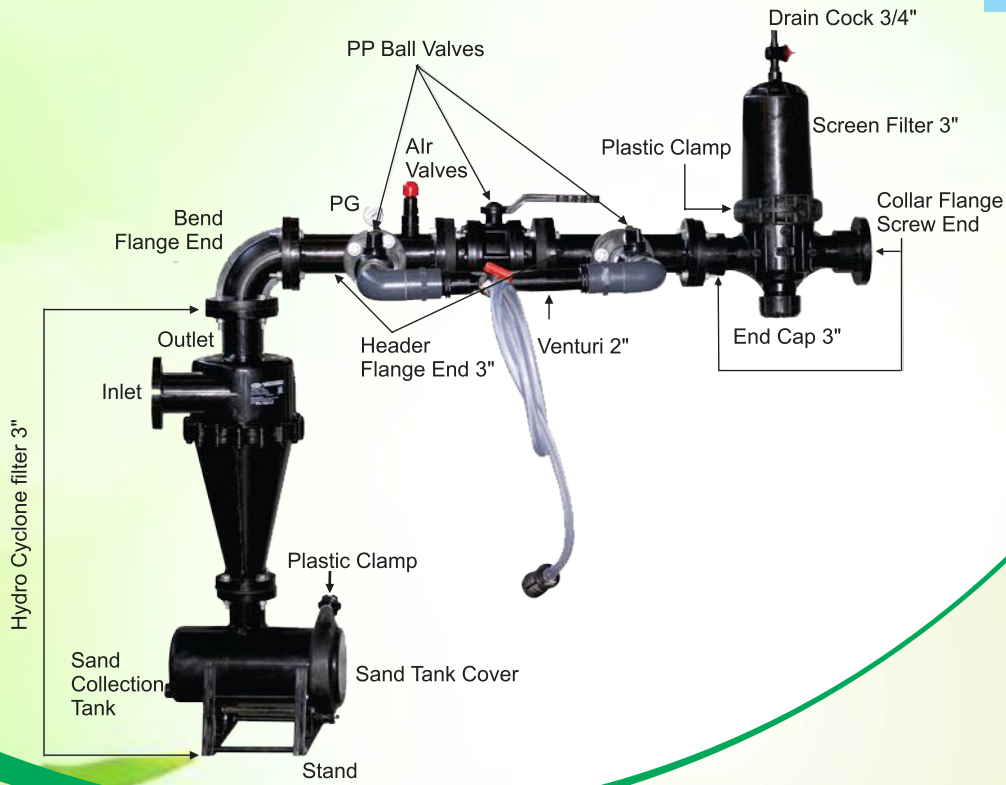

HydroCyclone (2", 2.5", 3")



Flanged Valve (2", 2.5", 3")



PP Flanged Elbow (2", 2.5", 3")



PP Flanged Tee (2", 2.5", 3")



Disc Filter (2", 2.5", 3")

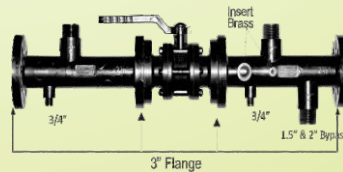

PP Header (2", 2.5", 3")

Welldrip Polyplast

Mfg of : All Type of Irrigation Products.

📍 Add. & Factory: 61, Abhisek Estate, Nr.Girnar Scooter Compound, Odhav, Ahmedabad-382415

✉ Email : welldrrippolyplast@gmail.com

☎ Mo.98791 14661, 98258 23270

📞 70465 57987

📱 @welldrip.polyplast